

YA-D5-11

User Manual

Electric ICU Bed

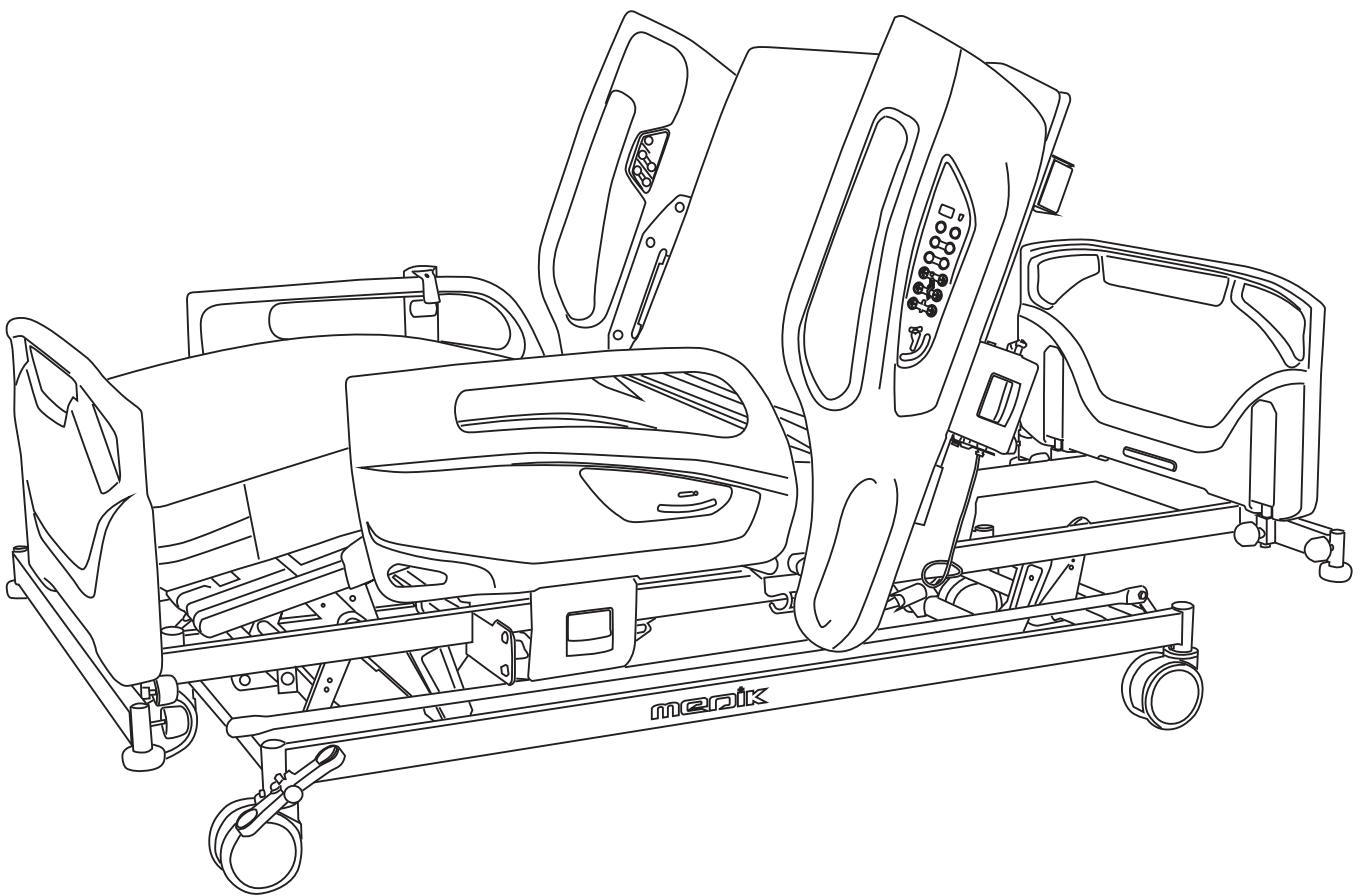

Profession with 20+ years experience!

Always alleviating medical staff's workload.
Always improving patient's safety and comfort.
Always minimizing the medical incident.

Zhangjiagang medi medical equipment co.,ltd, founded in 1995, with more than 20 years experience in developing hospital furniture, is one of the largest manufacturer of hospital bed, patient stretcher, medical cart and other related hospital furniture in china or even asia.

Through scientific management complying with iso9001&iso13485, by adopting advanced facility like germany trumpf cnc, japan otc robot welding, auto-power coating line with swiss gema gun , medi focuses on providing brand quality product with ce approval.

Headquartered in zhangjiagang nearby shanghai, with subsidiary oversea offices in hungary, dubai, thailand, new zealand, kenya, colombia, medi acting professionally and swiftly for both pre-sales and after-sales.The products are widely accepted by global clients, such as uk rie hospital, univerzitetni klinicni center, kokilaben dhirubhai ambani hospital, singapore national university hospital etc.

Zhangjiagang Medi Medical Equipment Co.,ltd.

Table of contents

General Attentions	3
Safety.....	4
Proper Use and Application.....	5
Introduction	6
Description of Parts	7
Technical Data	8
Transport and Unpacking.....	9
Installation and First Use	10
Evaluation Criteria	11
Application of Product's Function	12
Central Brake System	13
Electric control.....	14
Bed Positioning.....	15
Battery.....	16
X-ray examination(Optional).....	17
CPR & Emergency Stop.....	18
Side rail	19
Head/Foot Board.....	20
Accessory Assembly and Use	21
Damages and Defects	22
Repairs and Maintenance	23
Cleaning and Disinfecting	24
Trouble Shooting.....	25
Storage	26
Products Scrapped.....	27

1 GENERAL ATTENTIONS

Dear Clients



Great appreciation to you for choosing this bed from our company, we wish you would find much satisfaction while using it. Please read this manual carefully, in which includes all the significant information and Attentions to guide proper installation and operation of the product as well as its servicing.

- 1 The use, maintenance as well as servicing of this product are performed in any other ways than those, which have been stated in this manual is not allowed and may result in damages, which will encumber the user and which will not be a matter of producer' s responsibility.
- 2 Any consequences resulted by those users who are not trained with the manual are derelict of duty by our company.
- 3 When parameters of the product do not match the description in item 'Technical data' in this manual, the use of the product is not allowed and any defects have to be reported to the producer or the supplier.
- 4 Every repair of the product must be done by manufacturer or the authorized organ and recorded on the list of repairs, which is supplied with the guarantee certificate. Disregarding this requirement will cause the guarantee for the product to be invalid. (The concerned matters of repair are referred to the maintenance manual.) Before starting any repair the cable must be disconnected from mains.
- 5 The sign shown below means: 'Caution – pay especial attention to the Operating Manual' .



- 6 This sign is placed on any parts or mechanisms, which may prove to be harmful to the patient or the personnel if their operation does not comply with the descriptions in the Operating Manual.
- 7 All rights are reserved to Zhangjiagang Medi Medical Equipment Co., Ltd. This manual should not be reproduced or transmitted without our prior permission.
- 8 The producer reserves the copyright and the right to make changes in this User Manual due to technical changes or improvements of the product. The contents of this manual may differ in minor detail from the basic product design.

Zhangjiagang Medi Medical Equipment Co., Ltd

- 1** The structure of the product assures its safe operation on condition that the rules comprised in this manual are followed.
- 2** Prior to use, the user should read all following safety introduction and check all bed' s functions item by item according to this manual. Make sure that there are no problems then bed can be used.
- 3** The total weight of a patient and additional accessories installed on the bed should not exceed 230kg; the weight of the patient should not exceed 200kg. If in a short period the load of the bed exceeds 200kg due to the cardiopulmonary resuscitation, please lower the bed pallet to the lowest position.
- 4** This bed is designed for patients, any other person is forbidden to sit on it.
- 5** The height of the patients shall not exceed 200 cm.
- 6** The functions which may cause harm to patient must be locked when patient is left without medical supervision.
- 7** If the patient' s state (e.g. disorientation for medical or clinical reasons) may lead to patient' s entrapment, the pallets should be placed in a flat position if the patient is left without medical supervision (except individual medical advice or particular circumstances).
- 8** If the patient can not be level-headed, please lock the side rail controllers to avoid false manipulation injuring the patients.
- 9** When bed is not transferring, please use the castor lock lever to lock the bed, otherwise the patient may be hurt when their going up and down or lying in the bed.
- 10** The user should avoid the danger to safety caused by the improper link of cables connected to mains, e.g. stretching or extruding the cables.
- 11** The user should avoid the wire is pressed under the castor, cables squashed between the foot board or the head board and the moving parts.
- 12** If there are using equipment or frequently used equipment near the bed, or the bed is at a cardiac chair position, the operation must comply with the descriptions in this User Manual; otherwise it might cause a series of serious accidents. For instance, the metal parts or other equipment might cause serious harms to patients.
- 13** If the patient is left without medical supervision, in order to decrease possible risks caused by patient' s falling down when going up and down from the bed, please adjust the bed to the lowest horizontal position.
- 14** When one adjusts positions of bed, caregivers should take care to eliminate the risk of entrapment of patients, for the movements of any bed segments may cause changes of the position of the bed and the equipment around.
- 15** Make sure that the extension of the bed is locked after extending it. Otherwise there will be fatal danger in the process of patients' transferring. Caregivers are responsible for the complete locking of extension of the bed.
- 16** Manual CPR is extraordinarily important due to be used of rescuing patients. Caregivers should check whether they are in proper operating condition frequently. If not, please report to the service person in order to renew it as soon as possible. If caregivers do not report the possible malfunctions betimes, they should be responsible for all results caused by it.
- 17** When side rails are folded or upright, caregivers should pay attention to the safety of patients and themselves as well as other things because the general framework may clamp their hands, wires in side rails or any other things.
- 18** When the bed is elevating, caregivers should make sure bed' s elevation will not interrupts equipment around which will lead to dangers; also the bed' s lowering will not make equipment below squeezed.

3 PROPER USE & APPLICATION

Application



YA-D5-11 hospital electrical bed is designed for mid to high acuity patients population.

General requirements

The bed should only be used in an internal environment where:

- The ambient temperature ranges from +10°C to +40°C(Ambient temperature change range is less than 20 °C in 8 hours).
- The relative humidity ranges from 20% to 80%.
- The atmospheric pressure ranges from 860 to 1060 hPa.
- The product should be used according to the indications of this manual.
- The bed should be maintained and serviced according to special service manual.



Caution

- Using, maintaining and servicing of the product in other way than indicated in this manual are not permitted and may lead to damages, for which the user is to be blamed and for which the producer is not responsible.
- Installation of any other accessories not offered by the producer is allowed only on the basis of a written acceptance of the producer.

Duties of user

- User: any individual or corporation who uses the product.
- The user must ensure that the product shall be used exclusively in conformity with its destination and in appropriate conditions in accordance with this manual.
- The user is also obliged to take any necessary precautions in order to prevent any life and health hazards concerning the user, patients and any third party.
- Only authorized persons who underwent special training and peruse this manual can operate this product.
- The user must also ensure that any person who operates this product has read, understand and will follow the instructions included in this manual.



YA-D5-11 hospital electrical bed is designed and manufactured by Zhangjiagang Medi Medical Equipment Co., Ltd., which can be used in several kinds of ICU ward. It also can be applied to top grade ward, VIP ward as well as healing ward due to its multifarious functions and adaptability.

The electric actuators can adjust the movements of backrest, leg section, height, trendelenburg, and reverse-trendelenburg

The optional scale system reaches precision up to 200 grams, absolute and differential weight can be measured continuously. The bed is mounted on lockable, steerable castors for easy movement.

The bed is designed and manufactured in conformity with:

YY0571/IEC60601-2-38 Particular requirements for the safety of electrically operated hospital beds, GB9706.1/IEC60101-1 Safety requirements for medical electrical systems.

The manufacturer operates under quality management systems certified in accordance with: EN ISO 9001 and EN ISO13485.

5 DESCRIPTION OF PARTS

Segments

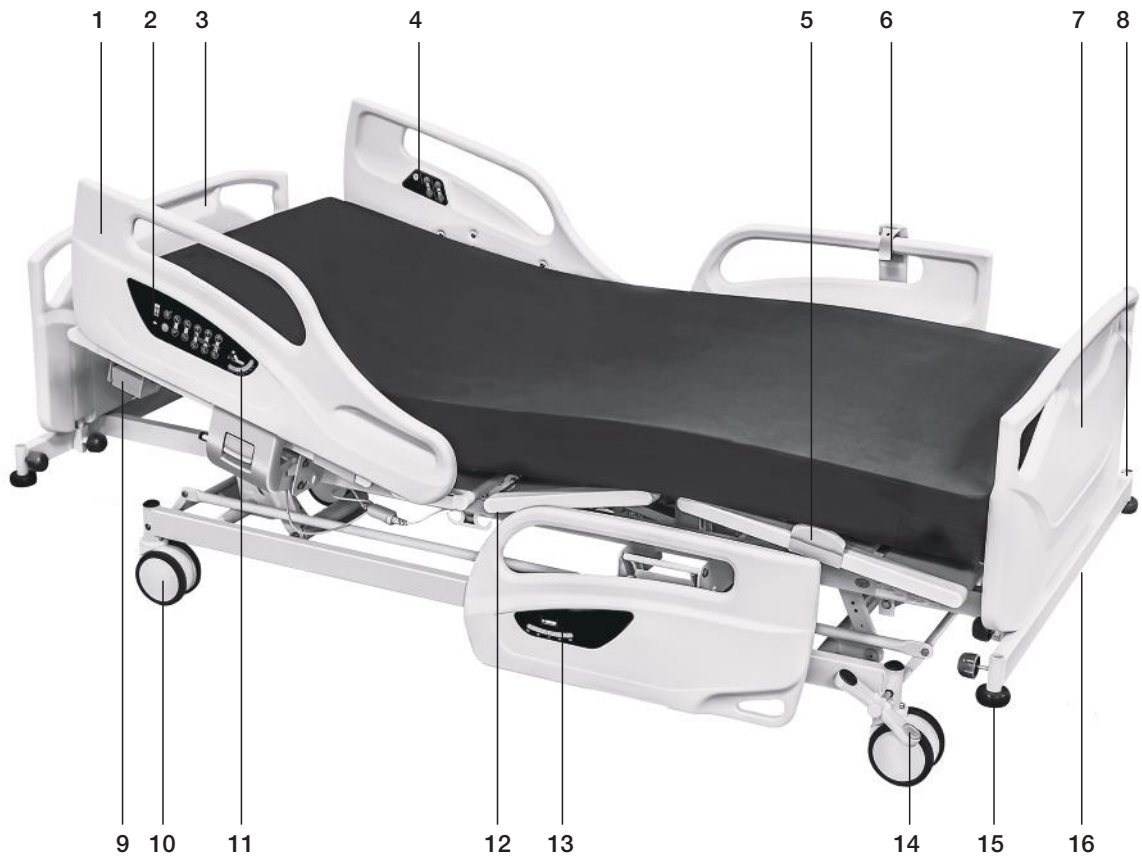

NO.	Description
1	Back side rail (Side rail close to head board)
2	Exterior control on the back side rail
3	Head board
4	Interior control on the back side rail
5	Mattress stopper
6	Handset control
7	Foot board
8	Sockets for I.V. pole

NO.	Description
9	Handle for mechanic CPR quick release
10	125mm casters
11	Angle indicator on the back side rail
12	Bed surface
13	Angle indicator on the sit side rail
14	Central brake system for casters (red on the pedal is brake, green on the pedal is release)
15	Bumper castor
16	Patient scale system (Optional)

Mechanical and operating parameters

Parameters	Description	YA-D5-11
Length×Width	2000×900 mm	•
Overall Length×Width	2200mm x 990mm	•
Maximum height	770 mm	•
Minimum height	420 mm	•
Angle of backrest adjust	75°±5°	•
Angle of Thighrest adjust	35°±5°	•
Back CPR	Manual and Electric	•
Emergency stop	Single button on the handset control and	•
Tr/Anti-Tr position	12°±2°	•
Patient scale under the foot board	Optional	○
Exterior control on the Back side rail	Each side	•
Interior control on the Back side rail	Each side	•
Nurse control panel	Optional	○
X-ray examination	Back Complete patient lying surface(Optional)	○
Castors diameter	mm	125
Central brake	Foot pedal on both head and foot section	•
Scale system precision	200g	○
Removable head/foot board		•
IV pole holder	Each corner	•
Bumper caster	Each corner	•
Oxygen tank holder	Optional	○
Drainage hooks	On both sides of bed	•
Battery	Yes	•

Electricity parameters

Parameters	Description	YA-D5-11
Rated voltage	50-60Hz /220V-230V; 50-60HZ/110V-120V	
Input power		368VA
Protection against electric shock		Class I/B
Protection degree		IP-X4
Usage period		10 Year

Critical parameter

Parameters	Description	YA-D5-11
Maximal workload	kg	230
Maximal load of IV pole	2 kg each hook	•

7 TRANSPORT AND UNPACKING

Transport

 There is a possibility to transport the product by any covered transport means, it can be transported by highway, railway, waterway, and air transportation. While transporting, it is necessary to immobilize the truck and protect it against water and moisture. The transport conditions are as follows:

Parameters	Description
Temperature	from -10 C to 60 C,
Relative humidity	from 20% to 80%
Atmospheric pressure	from 860hPa to 1060hPa



Caution

- In the process of products' transporting, storage and unpacking, the temperature gradient should be less than 10 C per hour. It is recommended to unpack the product after reaching room temperature.

Attention must be paid to the following

 In case of a significant difference between transport and storage temperatures, the product should be left for minimum 12 hours before putting it in motion. Stored storage is required in accordance with the packaging marking. In case of the specific transport conditions (particularly excessively low temperature), it is necessary to negotiate with the manufacturer or local agent in order to ensure the products' transportation safety.

1

Unpacking

The bed is shipped in an assembled form in a wooden case and castors have been locked. The mattress is packed with LDPE plastic casing and the bed is packed with polyethylene foam to avoid damage during the transportation. The bed should be unpacked indoors in order to prevent from damages.

One who uses this bed for the first time should accomplish the preparations as follows:

- Mark the fittings and make a record;
- Remove the materials protecting the bed.

2

Attention must be paid to the following

Packaging waste is recyclable and should be segregated before removed to a disposal site. Unpack and assembly as followed orders:

- Take out affiliated components and put them aside. Release castor stops.
- Release the castor lock lever (as described further in this manual).
- Take the bed from the pallet carefully and stop it with the help of another person.



Caution

- When moving the bed, do not hold the plastic components to avoid damages.
- The bed should be uplifted from the wooden box totally. It's forbidden to unblock the central brake system and push the bed out of the wooden case, for which will cause damages to the cables of actuators below the base.



Check whether the equipment provided fit the documentation enclosed. Put the product in its destination which meets the requirements set in this manual. Read this User Manual carefully. Start up the product as described in item: 8. Installation and first use.



Caution

- If the functions of the bed are not consistent of the data in the manual, the use of the bed must stop and this situation should be reported to manufacturer or supplier. Using inefficient product may lead to damages, which burden the user and for which the manufacturer do not take responsibility.

Place the bed in the needed working room.

Block castor lock lever.



Caution

- All electric devices connected directly with the patient should be connected with potential equalization installation.
- In case of potential equalization installation lack in the bed installation place these devices should be connected by means of potential equalization wire with potential equalization socket in the bed connecting panel.

- The weight scale system can be operated normally after open the knobs which protect the weight sensors that is under the cover.
- Rotate emergency button, the main box will connect with the battery box with a buzzer.
- Check all controllers that are connected well(the touch screen, side rail controllers and the foot controller).
- Check lock functions of touch screen and side rail controllers that is correct.
- Check inclination angle of back board.
- All movements executing accordingly to descriptions enclosed relating chapter 13.
- After check all functions, connect the bed to the mains and make sure the power supply is in gear.
- Bed' s mechanisms should be silent and smooth without stopping and creaking during executing all checking functions.
- The noise of mechanisms and electric actuators should not exceed 65dB(A) at the distance of 1 meter from the bed.
- Head board and foot board are connected through inserting to the reserved corresponding jacks.(see chapter 18).



Caution

- Only when the bed is installed and make sure there is no any short circuit or wrong connection one can electrify and check it.



Caution

- If the bed can not work properly or the mechanisms can not work smoothly and silently it is not allowed using the bed. Such a situation must be reported to the producer or supplier.
Using inefficient product may lead to damages, which burden the user and for which the producer do not take responsibility.

9 EVALUATION CRITERIA



Caution

- Correctness of bed functioning shall be checked before the first start up.
-

The method of checking whether the functioning of the bed is correct:

- 1** Check stability of the bed when its wheels are locked by trying to move the bed manually: pushing the bed should not cause tilting or moving in any direction.
 - 2** Check the activity of all bed functions, which are performed in full range of movement data (height and angle adjustment of the pallet, angle adjustment of backrest and thigh rest).
 - 3** During every checking activity described in this item, the bed mechanisms should work quietly and smoothly, without scratches, creaks and the like. The bed mechanisms and electric actuators during the work emit the noise which does not exceed the value of 65dB (A) in a distance of 1 meter from the bed.
 - 4** Check the correctness of the all electrical steering elements (including touch screen, side rail controllers and foot controllers).
 - 5** Check the correctness of all blockade functions.
 - 6** Check the weight scale system. Place a greater than 1 kg of goods to the central bed board; See the changes in weight data(Optional).
-



If the bed underwent the above described tests with positive results and there were no disturbing sounds (squeaks and grinds), the bed can be used safely.

Bed height adjustment

The pallets can be vertically adjusted between 420mm and 770mm.

Bed's angle inclination (Trendelenburg and Anti-Trendelenburg position)

The bed can be tilted to Trendelenburg or Anti-Trendelenburg position in 12°. The Reverse-trendelenburg one can provide better drainage for the patient after operation, while the Trendelenburg can heighten the quantum of the blood supplies to the heart and brain.

Backrest adjustment

The back segment can be adjusted at a 75° angle, which is convenient for patients and caregivers to choose an appropriate position, especially for thoracic and celiac drainage as well as ascites.

Thigh rest adjustment

The thigh segment can be adjusted at a 35° angle in order to cure and caregiver the patient with lower limbs disease, reduce the pressure of the lower limbs and the abdomen to avoid the wound split.

Auto-Regress

The back rest and the Thigh rest will be retractable when they are folded up, which can make the patients feel more comfortable by reducing the pressure on the back and the abdomen to avoid the bedsore and the wound split as well as prevent the gliding of the mattress and the patients. The back board's minimum movement distance is 60mm, while the thigh rest segment's is 40mm.

Fowler position

Fowler position can be achieved by one single button.

CPR function

Both mechanic and electric CPR functions are available on this bed, The mechanical CPR can be realized by the levers on both sides of bed, while the electric CPR can be realized by one single button.

X-ray examination (Optional)

There is a X-ray cassette tray under the back section, and you can put the X-ray cassette under the back section.

Patient scale system (Optional)

The weighing function provided by patient scale system to help the caregiver to learn the patient's status much better.

11 CENTRAL BRAKE SYSTEM

- i** The bed is equipped with a caster lock lever, by which the caster can be locked and unlocked with one motion. The bed is also equipped with fifth castor allowing easier movement of the bed in narrow spaces, such as passing in and out the lift, entering and leaving the ward etc.



The central braking lever can be set to two positions:

- A Lock**
As seen in Fig1 1.1, step down the red pedal and all the casters are locked.
- B Unlock**
As seen in Fig1 1.1, step down the green pedal. All casters are unlocked, the bed can be moved.

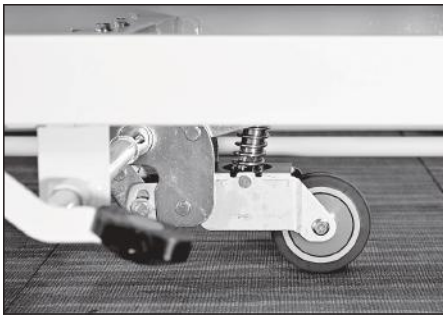

Fifth Castor



Caution

- Before moving bed, one shall disconnect it from mains and adjust the bed to horizontal level.
- The floor under the bed must be free of obstacles.
- Avoid any collisions during the bed maneuvering as it may cause damages to the scale sensors.

The electric control on the bed includes

- Exterior electric control on Back side rail (see 12.1)
- Interior electric control on Back side rail (see 12.2)
- Handset control (see 12.3)

11.1 Exterior electric control on Back side rail

The main control for caregiver is incorporated on the exterior side of the Back side rail(Close to the head board),Main functions of the electric control:



Fig 12.1

- Back section adjustment
- Knee section(Leg section)adjustment
- Trendelenburg and Reverse-trendelenburg movements adjustment
- Height adjustment
- Auto-contour
- Locking function for all the movements
- Electric CPR
- Indicator for the bed at the lowest position
- Indicator of the battery status
- Angle indicator



Caution

- Only caregiver or under the direction of the caregiver can operate the touch screen.

11.2 Interior electric control on Back side rail

Main functions of interior control on the Back side rail (Fig. 12.2)

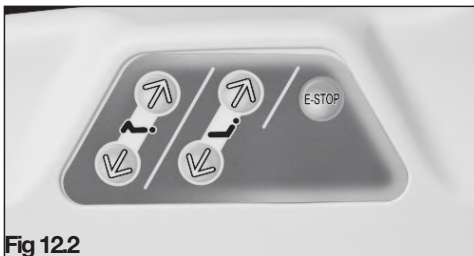

Fig 12.2

- With "Emergency Stop" Button
- Knee section(Leg section)adjustment
- Back section adjustment

11.3 Handset control on side rail

Main functions of interior control on the sit side rail (Fig. 12.3)



Fig 12.3

- Back section adjustment
- Knee section(Leg section)adjustment
- Trendelenburg and Reverse-trendelenburg movements adjustment
- Height adjustment
- Auto-contour
- "Emergency Stop" button
- Electric CPR

13 BED POSITIONING



- Adjustment angle of backrest: $0 - 75^{\circ} \pm 5^{\circ}$
- Adjustment angle of knee: $0 - 35^{\circ} \pm 5^{\circ}$
- HI-LO: 42 - 77cm
Trendelenburg and Reverse Trendelenburg 0 to $12^{\circ} \pm 2^{\circ}$
- Mechanic CPR: by Mechanical Levers located on each side of the bed, in a single step to perform CPR procedures
- Electric CPR via a single button on the handset control



Caution

- If patient is on the bed without any caregivers' supervision, the bed should be in the lowest position to prevent the risk of patient's falling.



Caution

- When adjusting bed basic positions, make sure that there is no part of the body squeezed between the patient surface and the frame of the bed.



Caution

- One should be careful while performing function changing. The segments moving may cause fingers or palm to be crushed. When adjusting, please do not rest your palm on the bed elements near the hinge.
- Attention must be paid to kinds of tubes and pipes which are connected to the patients, in order to avoid accidents caused by separating patients from the tubes and pipes.
- If patient is on the bed without any medical personnel supervision or any position changing is forbidden, the bed should be in horizontal position.



The battery is integrated in the control box as support in case of power failure.

15 X-RAY EXAMINATION (OPTIONAL)

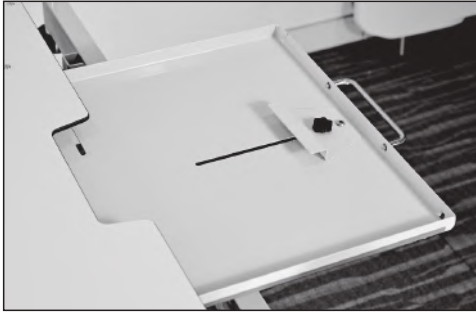

- The X-ray cassette holder tray can be inserted below the back section

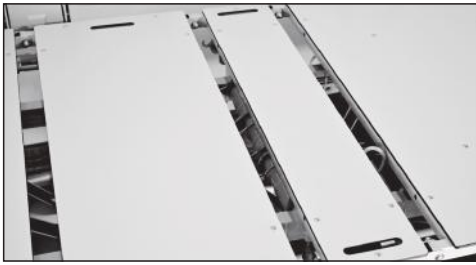

- Safe locker



- X-ray fluoroscopy plate

- Pull CPR handle outward, the backrest will quickly return to horizontal position.



• CPR



• Emergency Stop



Caution

- CPR is essential for patient's reanimation. Caregivers must regularly check whether CPR is out of work. It's very important to report to the manufacturer if it is found out of work. Caregivers will be responsible for all the results caused by not finding or not reporting to the manufacturer that CPR mechanism is out of work.
- Electric CPR also available on the exterior control of sit side rail and handset control. Emergency stop to protect the patients, and to stop the movements if the patients do not feel well. Press the button for stop and rotate the button in clockwise circle for release on the interior control of side rail and handset control.



SEGMENT SIDE-RAIL:

1 Fold down the side rail

The guardrail needs to be lifted slightly, and then the button can be pulled down to lower the guardrail. If the guardrail is not raised slightly, the guardrail will not be lowered (this design prevents the patient from lowering the guardrail from the inside of the bed).

2 Fold up the side rail

Pull upward the side rail and it will be upright. When you hear a sound "pa" , the side rail is locked.



- As shown in figure, head board /foot board is easily installed and removed by the screw . When installing and knocking down the head board /feet board, please energize symmetrically.

19 ACCESSORY ASSEMBLY & USE



- 1 IV Stand**
There are four IV stand sockets in the corners.



- 2 IV Stand**
There are 2 hooks on each side of bed, total is 4.

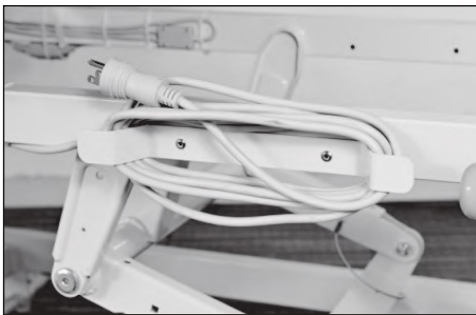

- 3 Winder**
When the power cord is not in use, it can be coiled.



- 4 Oxygen cylinder holder**
Removable oxygen cylinder holder.

i Damages and defects found in the product or accessories should be reported immediately to one who is in charge of such issues. The bed which can not be safely operated (damaged electric or manual elements) must not be used till it is repaired.

i Repairs must be done by the producer or an authorized service. The user can not carry out any repairs on his own unless he has undergone special training or has been authorized to do that.

To provide safe and reliable operation of the product, one should use only spare parts provided by the producer. Worn out parts shall be removed as provided in environmental protection regulations.



Caution

- The product contains elements which may be harmful to the environment: Oil (pneumatic spring), Gel battery. Please deal with these used products according to local rules.

i Every repair of the product must be recorded on the list of repairs enclosed with the guarantee certificate. Disregarding this requirement will cause the guarantee for the product to be invalid.

To ensure the safety and stability of the bed, regular check of the bed by the producer, authorized service or personnel is necessary.



Caution

- Service and repairs should be recorded on a list of repairs enclosed with product guarantee certificate.
- Only a positive result of product inspection can be the basis for its further operation.

Items to be checked	Frequency
<ul style="list-style-type: none"> • Checking the overall technical condition (according to service manual) • Checking the insulation of network 	Every year

i In order to ensure safe and proper operating and longevity of the product, every six months the following actions should be performed.

Base	Testing screw joints
	Testing the performance of the central lock and the traction system
	Testing the electric system of steering
Structure	Testing screw joints and protections on the ball pins
	Lubricate with the lubricant OBEEN UF3 from OPTIMOL (supplier: CASTROL)
	Testing mechanism of pulling aside of bedside rails
	Testing work of electric actuators
	Check the function of manual CPR and entire lock of bed extension
	Check whether the head/foot board can be disassembled
Controller	Check the performance of side rail controller and the touch screen



The checkout should be performed by visual inspection and the noticed malfunctions should be handled as in "Trouble shooting" .

The Cleaning and disinfecting of Mattress



Use alcohol to disinfect the bed.

After disinfecting, wash the product with distilled water to remove stains. After disinfecting, dry it thoroughly. Dry it with hot air (max. temp. 60° C) or wipe it with a soft sterile cloth.



Caution

- Cleaning and disinfecting should be carried out only when necessary using the minimal amount of fluid.
- The product must not be disinfected in disinfecting chambers.
- Bleaching (containing active chlorine or oxygen), caustic and corrosive agents must not be used.
- It's forbidden to clean plastic elements with organic solvents.
- Before cleaning or disinfecting disconnect from mains.
- During cleaning and disinfecting of controllers, be particularly careful. If the control gets drenched, dry it as soon as possible and dry its edges with a cloth.
- Disregarding the above requirements concerning cleaning and disinfecting shall result in losing the guarantee for the product.

The Cleaning and disinfecting of Mattress



Mattress

The mattress consists of the cover and inner cushion. Wash them separately. The cover of the mattress is made of a cotton or steam-permeable cloth. The inner cushion is made of polyurethane foam which can be removed from the cover after it's unzipping. Information on the quality of the cloth and washing conditions is provided on a label on the cover of the mattress.



Mattresses jacket

- Maximum temperature 95 °, Ordinary washing machines, general cleaning and washing the general roll.
- Not directly ironing may use steam Ironing.
- Not use organic solvents and chemical decontamination reagents.
- Not use chlorine bleach.
- Not rolling dry.



Inner cushion (polyurethane foam)

Wash them with mild detergent. It's allowed to disinfect for 15 ~ 20 minutes with the steam sterilization where the pressure is 0.25kp/cm² and the temperature is 105 ° C at maximum. Cleaning should be completed in 70 ° C for three hours drying.

- Not used in reactive oxygen species and reactive chlorine bleach.
- Not use organic solvents and alcohol.
- Not roller washing.



Caution

- Violation of the matters related cleaning and disinfection above will result in losing the guarantee for the product.

23 TROUBLE SHOOTING

	Possible causes	Remedy
The bed does not move	Locked wheels	Unlock the central lock
The bed cannot be steered	The 5th steering not touching the ground caster	Step down the pedal for steering caster again
The controlling system is out of work	Power cord disconnected from mains and Battery is low	Connect the power pug of the bed to power point
	Damaged controlling system	Report to the manufacturer
One or few of actuators are not working	Plug of the actuator is not connected well with the main box of controlling system	Check the connection between the plug of the actuator and the main box of controlling system
	It' s locked buttons by some locking	Unlock
	Damaged actuators	Report to the manufacturer
Bed does not move at all with sound of alarm	The software does not run in order	Restart the controlling system by disconnecting the cable connection between the battery box and the main box of the controlling system and connecting them again.
The height of the bed can not be adjusted	The bed is over loaded	Reduce the load to less than SWL225kg
	The battery is low and the power plug is not connected to the power point.	Connect the power plug of the bed to the power point on the wall
	The lifting actuators is damaged	Report to the manufacturer



Caution

- If troubles can not be shot according to the methods in the table, please notify the supplier immediately.
- Do not try to replace or change the equipment by strength.
- Producer takes no responsibility for ignoring the warnings above.

-
- If not to be used for a long time, it should be stored in the following conditions: temperature: $-10\text{ }^{\circ}\text{C} \sim +60\text{ }^{\circ}\text{C}$ (best temperature suggested: $25^{\circ}\pm 10\text{ }^{\circ}\text{C}$) relative humidity: 20% \sim 80%
-

**Attention:**

- Periodically wash and preserve stainless steel elements with paraffin oil. Washing and preservation operations shall be repeated every three months.
 - Disconnect the power plug to the power point and disconnect the connection between the main box of controlling system and the battery box.
-

-
- i** According to The Environmental Protection Ordinance, all of these products are environmental pollutants (whether disinfected or not), the users have obligation to deal with the products scrapped in the right way.
-

Process

- Give the product to company with environmental approach to the use of scrap materials.
- Give the product to Manufacturers with environmental approach to the use of scrap materials.
- Give the product to the corresponding authorized bodies or transshipped to manufacturers to disposal.

Attention

- Remove batteries[Harmful substances]
 - Disassembling the electronic components
 - Removal of electronic devices
 - Remove plastic parts
 - Remove metal components
 - Remove the processing components : Demolition should comply with the Environmental Protection Ordinance
-

CONTACT US



Youtube



Web

Pls scan the QR code for more info

-  + (86) 139 6223 1292
-  info@medik-medical.com
info@mediksurgical.com
-  www.medik-medical.com
www.mediksurgical.com